

GD100 F200 Integration

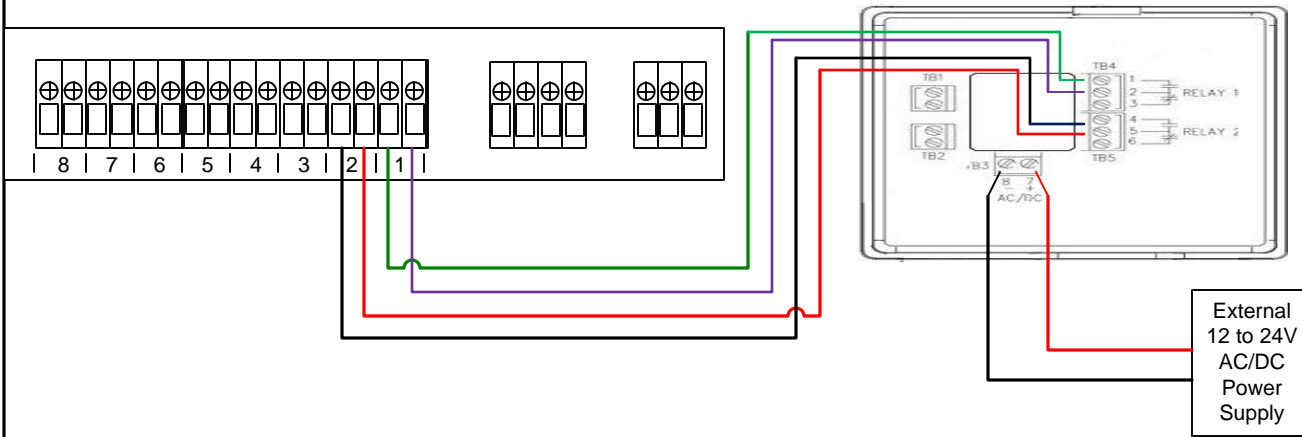

Figure 1.1: F200 Wiring

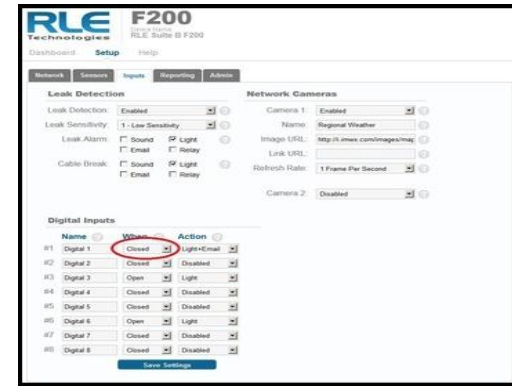

Figure 1.2: F200 Input Configuration Interface

F200 Setup

Set Input
Type to
Alarm On
Closed



AFS-D F200 Integration

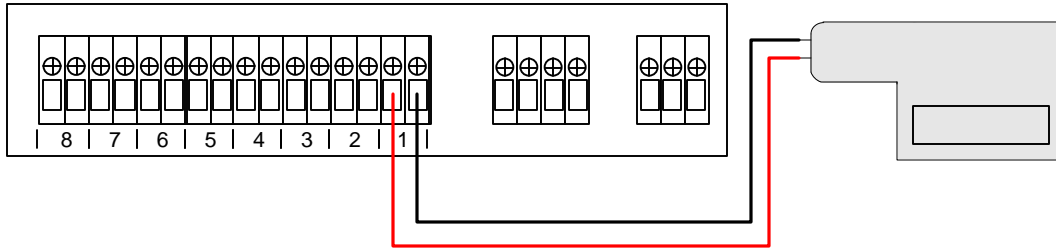

Figure 2.1: F200 Wiring

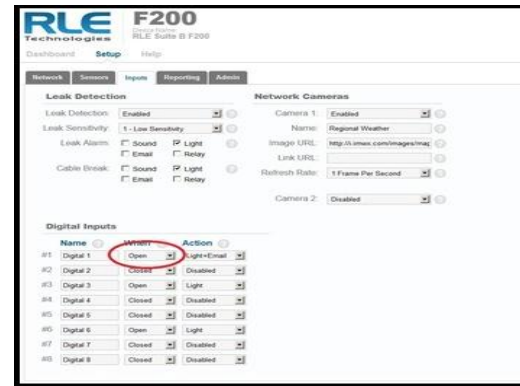

Figure 2.2 F200 Input Configuration

F200 Configuration

Set Input to Alarm On Open



MD3 F200 Integration

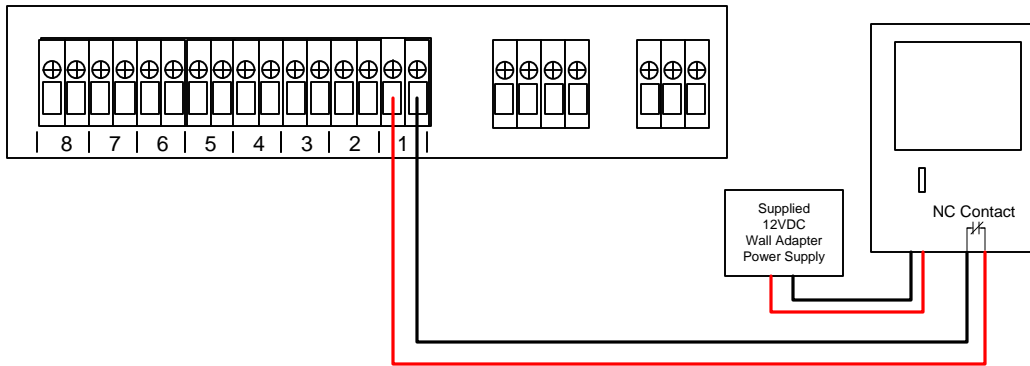

Figure 3.1: F200 Wiring

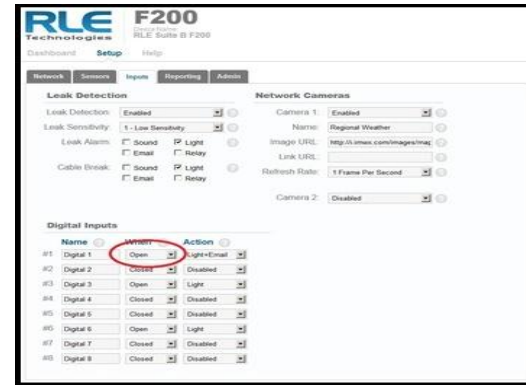

Figure 3.2: F200 Input Configuration Interface

F200 Configuration

Set Input Type to Alarm on Open



MDS F200 Integration

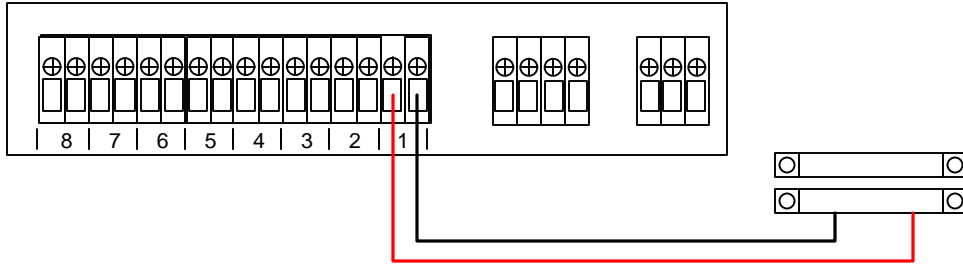

Figure 4.1: F200 Wiring

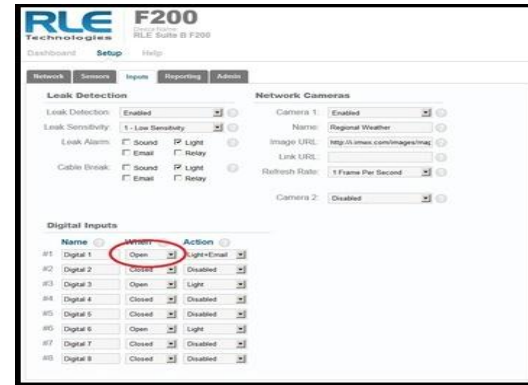

Figure 4.2: F200 Input Configuration Interface

F200 Configuration

Set Input Type to Alarm on Open.



SMK F200 Integration

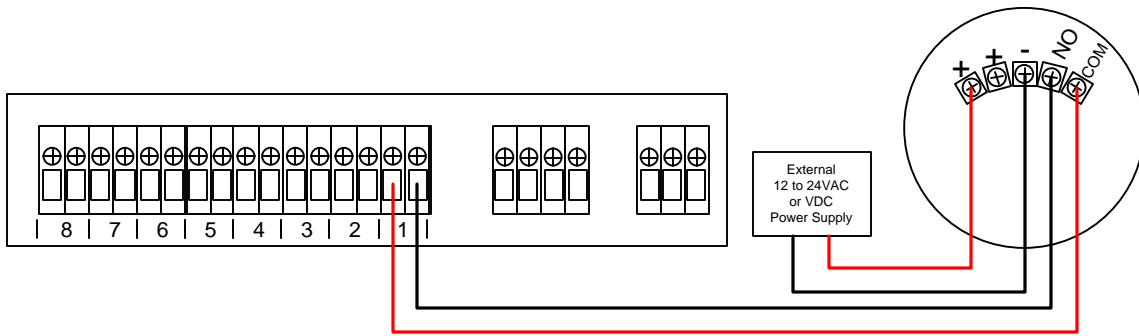

Figure 5.1: F200 Wiring

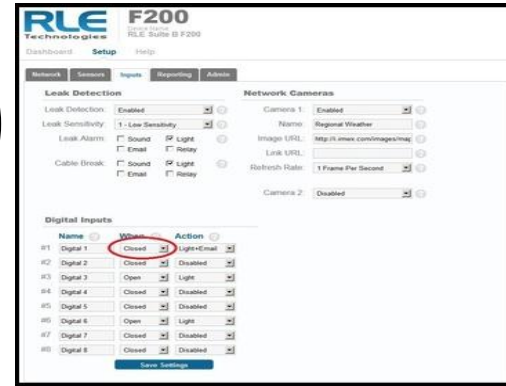

Figure 5-2: F200 Input Configuration Interface

F200 Configuration

Set Input Type to Alarm on Closed



HD150 & HD150-2 F200 Integration

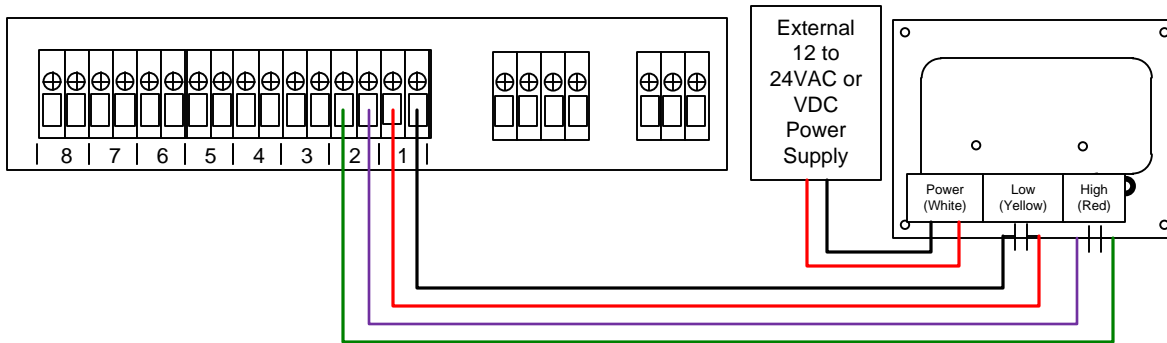
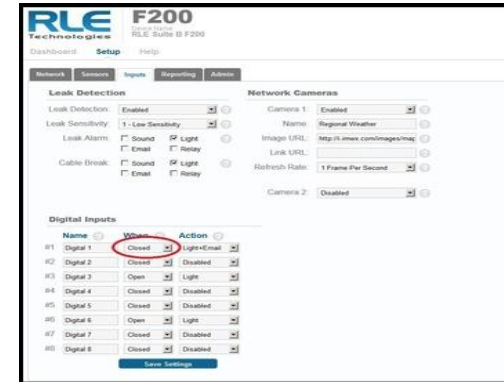

Figure 6.1: F200 Wiring



F200 Configuration
Set Input Type to
Alarm On Closed

Figure 6.2: F200 Input Configuration Interface