



# LDRA6

# User Guide

**User Guide Version 07.22**  
**Documented Using Firmware Version 2.4**



## Copyright and Trademark Notices

© Raymond & Lae Engineering, Inc. 2011. All rights reserved. RLE® is a registered trademark and Seahawk™, Falcon™, and Raptor™ are trademarks of Raymond & Lae Engineering, Inc. The products sold by Raymond & Lae Engineering, Inc. are subject to the limited warranty, limited liability, and other terms and conditions of sale set forth at <http://www.rletech.com/>.

## Revision History

Rev. No.	Date	Rev. No.	Date
2.0	June 2010	07.22	July 2022
2.1	January 2011		
2.2	February 2011		
2.3	October 2014		
2.4	September 2015		
2.5	December 2016		
2.6	November 2020		
05.22	May 2022		

## Manufacturer's Notes

This product is manufactured by RLE Technologies, 104 Racquette Drive, Fort Collins, CO, 80524.

If this product is used in any manner other than that specified by the manufacturer, the protection provided by the equipment may be impaired.

## Product Warranty

Warranty information for RLE products can be found at [www.rletech.com](http://www.rletech.com).

## Product Registration

Product registration helps RLE Technologies inform owners of:

- Product upgrades
- Firmware enhancements
- New products and technologies
- Special offers available only to registered users

Any information provided to RLE Technologies through the registration form will be regarded as confidential. RLE will not sell or distribute any of the information to third parties.

## Technical Support

Before you install an LDRA6, refer to RLE Technologies' website, [www.rletech.com](http://www.rletech.com), to ensure you are using the most recent version of all documentation.

Personal assistance is available Monday through Friday, from 8:00 a.m. to 5:00 p.m. MST.

A request for assistance may be sent to [support@rletech.com](mailto:support@rletech.com).

Otherwise, please call us directly at: **800.518.1519**.

The following information is located on the bottom of each LDRA6 unit. Please have this information available whenever a technical support call is placed:

Product Model Number \_\_\_\_\_  
Product Serial Number \_\_\_\_\_  
Product Manufacture Date \_\_\_\_\_

The LDRA6 is not a field-serviceable item and must be sent back to RLE Technologies for mechanical repair. Power must be disconnected (unplugged) from the LDRA6 any time the unit is mechanically serviced. Physically unplug power from the unit any time you are making wiring connections to or from the LDRA6.

RLE cannot accept an item for repair without a Return Materials Authorization number, which must be provided by RLE



# Contents

<b>1</b>	<b>Product Overview</b>	<b>11</b>
	Description	11
	LDRA6 Front Panel Indicators	12
	Zone LEDs	12
	Power LED	12
	Audible Alarm	12
	Quiet/Test/Reset Switch	12
<b>2</b>	<b>Connections and Settings</b>	<b>13</b>
	LDRA6 Board	13
	TB1 — Input Power	14
	POW1 — Input Power	14
	TB2, TB3 – Zone Inputs	14
	TB5, TB4 – Zone Alarm Relays	16
	TB6 – Summary Relay	17
	TB7 – RS485 Connection	17
	SW1– Relay and Alarm Function	18
	SW1, Position 1: Summary Relay Supervised/Unsupervised	18
	SW1, Position 2: Relays Latched/Unlatched	18
	SW1, Position 3: Zone Relay Linkage	18
	SW1, Position 4: Zone Relays Supervised / Unsupervised	18
	SW1, Position 5: Leak Alarm Delay	19
	SW1, Position 6: Ability to Silence Summary Relay	19
	SW1, Positions 7 and 8: Re-alarm Time	19
	SW2 – Modbus Addressing	19
	SW4 through SW9	20
	R1 – Leak Detection Cable Sensitivity Setting	21
<b>3</b>	<b>Installation</b>	<b>23</b>
	Before You Begin	23
	Connect the Water Leak Detection Cable	23
	Secure the Cable to the Floor	24
	Recommended Cable Installation	25
	Apply Power to the Unit	26
	Power via Wall Adapter	26
	Power via Direct Line	26
<b>4</b>	<b>EIA-232 Interface</b>	<b>27</b>
	Boot-Up	27
	Help Menu	28
	Function Commands	28
	c – Contact Closure Settings	28
	ld – Leak Delay Setting	29
	sens – Leak Zone Sensitivity	29
	e – View Eeprom Data	30
	er – Erase Eeprom Data – Restores Factory Defaults	30
	mbb – View / Change Modbus Baud Rate	30

mbp – View / Change Modbus Parity . . . . .	32
mr – Reset Modbus Port and Statistics . . . . .	32
m – View Modbus Port Settings and Statistics . . . . .	33
t – Toggle Modbus Trace On/Off . . . . .	33
z – Display Leak Zone Readings . . . . .	33
sr – Summary Relay Mode . . . . .	33
zr – zone relay mode . . . . .	34
x – Exit to Bootloader . . . . .	34
<b>A Modbus Communications . . . . .</b>	<b>35</b>
Modbus Implementation of the LDRA6 . . . . .	35
Modes of Transmission . . . . .	35
Slave Address Field . . . . .	35
Function Field . . . . .	36
Data Field . . . . .	36
Error Check Field . . . . .	36
Packet Communications for the LDRA6 . . . . .	36
Read Output Registers . . . . .	36
Read Input Registers . . . . .	37
Present Single Register . . . . .	39
Present Multiple Registers . . . . .	40
RTU Framing . . . . .	41
Modbus Mirroring . . . . .	42
Modbus 485 Termination . . . . .	42
<b>B Troubleshooting . . . . .</b>	<b>43</b>
<b>C Technical Specifications . . . . .</b>	<b>45</b>

# Figures

<b>1</b>	<b>Product Overview</b> .....	<b>11</b>
	Figure 1.1 LDRA6 Front Panel Indicators .....	12
<b>2</b>	<b>Connections and Settings</b> .....	<b>13</b>
	Figure 2.1 LDRA6 Circuit Board .....	13
	Figure 2.2 TB1 - Power Terminal Block .....	14
	Figure 2.3 POW1 - Input Power Connection .....	14
	Figure 2.4 TB2, TB3 - Sensing Cable Input Terminal Blocks .....	14
	Figure 2.5 TB4, TB5 - Alarm Relay Output Terminal Blocks .....	16
	Figure 2.6 TB6 - Summary Relay Output Terminal Block .....	17
	Figure 2.7 TB7 - RS485 Terminal Block. ....	17
	Figure 2.8 SW4 - SW9 Zone Configuration Switches. ....	20
	Figure 2.9 R1 - Adjust Leak Detection Cable Sensitivity .....	21
<b>3</b>	<b>Installation</b> .....	<b>23</b>
	Figure 3.1 Water Leak Detection Sensing Cable Connection .....	24
	Figure 3.2 SD-Z1 Spot Detector Connection .....	24
	Figure 3.3 Cable Installation Methods .....	25
	Figure 3.4 Wiring Diagram .....	26
<b>4</b>	<b>EIA-232 Interface</b> .....	<b>27</b>
	Figure 4.1 EIA-232 Interface - Bootloader Screen .....	27
	Figure 4.2 EIA-232 Interface - Help Menu .....	28
	Figure 4.3 EIA-232 Interface - Contact Closure Settings .....	28
	Figure 4.4 EIA-232 Interface - Display Current Leak Zone Settings .....	29
	Figure 4.5 EIA-232 Interface - Override Manual Leak Sensitivity Settings. ....	29
	Figure 4.6 EIA-232 Interface - Help Menu .....	30
	Figure 4.7 EIA-232 Interface - Modbus Parity .....	30
	Figure 4.8 EIA-232 Interface - Modbus Port Setting and Statistics .....	31
	Figure 4.9 EIA-232 Interface - Current Leak Zone Readings. ....	31
	Figure 4.10 EIA-232 Interface - Summary Relay Configuration .....	31
	Figure 4.11 EIA-232 Interface - Zone Relay Configuration .....	32
<b>A</b>	<b>Modbus Communications</b> .....	<b>33</b>
<b>B</b>	<b>Troubleshooting</b> .....	<b>41</b>
<b>C</b>	<b>Technical Specifications</b> .....	<b>43</b>





# Tables

<b>1</b>	<b>Product Overview</b> .....	<b>11</b>
<b>2</b>	<b>Connections and Settings</b> .....	<b>13</b>
<b>3</b>	<b>Installation</b> .....	<b>23</b>
<b>4</b>	<b>EIA-232 Interface</b> .....	<b>27</b>
<b>A</b>	<b>Modbus Communications</b> .....	<b>33</b>
	Table A.1 Read Output Registers Packet Structure .....	34
	Table A.2 Output Registers .....	34
	Table A.3 Read Input Registers Packet Structure .....	35
	Table A.4 Input Registers .....	36
	Table A.5 Status Flags (Register 30001) .....	36
	Table A.6 Status Flags (Register 30008) .....	37
	Table A.7 Preset Single Register Packet Structure .....	37
	Table A.8 Present Multiple Registers Packet Structure .....	38
	Table A.9 Modbus Slave Address .....	38
	Table A.10 Query Sample .....	39
	Table A.11 Response Sample .....	39
<b>B</b>	<b>Troubleshooting</b> .....	<b>41</b>
	Table B.1 Troubleshooting Problems with the LDRA6 .....	41
<b>C</b>	<b>Technical Specifications</b> .....	<b>43</b>
	Table C.1 Technical Specifications .....	43



# PRODUCT OVERVIEW

## 1.1. Description

The LDRA6 is a complete monitoring system that detects and reports the presence of water and other conductive liquids, as well as monitors dry contact alarm points. The LDRA6 couples SeaHawk Water Leak Detection Cable (SC) with an advanced control head to monitor six individual zones. When a conductive liquid comes in contact with the SC or Spot Detectors (SD-Z/SD-Z1), an alarm sounds and the summary alarm relay and zone relay activate. The LED that corresponds with the appropriate zone also illuminates and an audible alarm is activated. Each LDRA6 input can also be configured to detect a dry contact's change of state (NO or NC) and annunciate the alarm on the front panel.

The LDRA6 is a supervised system - it continuously monitors the cable for leaks and cable integrity. A cable break causes a cable fault indication. An alarm sounds and the appropriate zone relay and the summary alarm relay activate. The appropriate LED changes to indicate a cable fault has occurred.

The dry contact relays in the LDRA6 may be configured as supervised or unsupervised (see section 2-2 for configuration options). Each zone can be configured with unique, individual settings. When the user specified alarm condition occurs, the LDRA6 activates the appropriate relay and alarm LED

**Note** The LDRA6 produces an alarm in the following conditions:

- ◆ Leak Detected
- ◆ Cable Fault
- ◆ Dry Contact Alarm Condition (User Specified)

## 1.2. LDRA6 Front Panel Indicators

### 1.2.1 Zone LEDs

One tri-color LED for each zone.

#### Default Leak Detection Cable Setting:

- On solid and green for normal cable conditions.
- Flashes quickly and turns red if a leak is detected in the zone.
- Flashes quickly and turns yellow if a cable fault is detected in the zone.
- On solid once an alarm is silenced.

#### Default Dry Contact Setting:

- On solid and green for normal, non-alarm conditions.
- Flashes quickly and turns red (by default) if an alarm condition is detected in the zone.
- On solid once an alarm is silenced.

### 1.2.2 Power LED

On (green) as long as power is on.

### 1.2.3 Audible Alarm

Activates when an alarm condition is detected. Silenced with the Quiet/Test/Reset switch.

### 1.2.4 Quiet/Test/Reset Switch

During alarm, the audible alarm is silenced, and any LED(s) in alarm will glow solidly. If the alarm goes away, the LED(s) will flash slowly. Hold down the Quiet/Test/Reset switch to reset all alarms and complete and self test cycle. If any alarms still exist, the unit will not reset the corresponding zones.

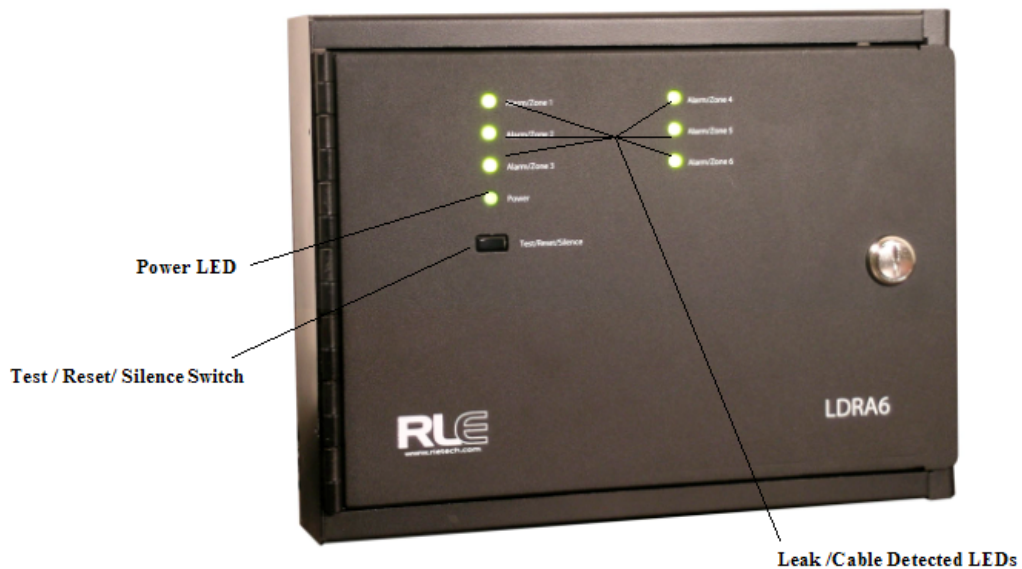

Figure 1.1 LDRA6 Front Panel Indicators

## CONNECTIONS AND SETTINGS

### 2.1. LDRA6 Board

The LDRA6's zone connectors, labeled TB2 and TB3, are found at the bottom of the right side of the board. The switches on the board labeled SW1 control some relay and alarm functionality. SW2 sets the Modbus station address. The unit has one dial, labeled R1, which is used to manually adjust the sensitivity for all zones. Sensitivity for individual zones may be configured through the LDRA6's EIA-232 Craft Port configuration, labeled P2. The switches for configuring Dry Contact or Leak Detection monitoring for zones are labeled SW4 through SW9.

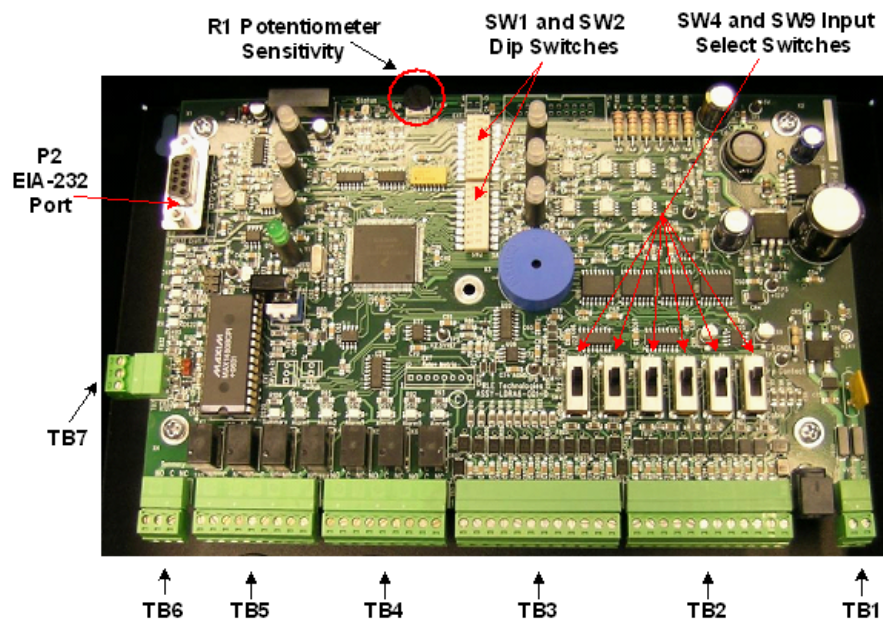

Figure 2.1 LDRA6 Circuit Board

### 2.1.1 TB1 -- Input Power

The LDRA6 requires an isolated power supply, RLE part PSWA-DC-24 (24VDC isolated supply). This power supply is not included with the LDRA6. It is available from RLE and sold separately.

Power can be wired to the LDRA6 through TB1. If you are using TB1 you may need to cut the barrel connector off of your power supply and strip the ends of the wires so they can be inserted into the terminal blocks.

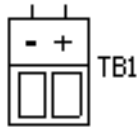

Figure 2.2 TB1 - Power Terminal Block

### 2.1.2 POW1 – Input Power

The LDRA6 requires an isolated power supply, RLE part PSWA-DC-24 (24VDC isolated supply). This power supply is not included with the LDRA6. It is available from RLE and sold separately.

Power can also be supplied to the unit through POW1. Plug the barrel connector of the isolated supply directly into POW1..

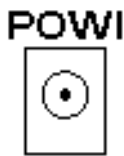

Figure 2.3 POW1 - Input Power Connection

### 2.1.3 TB2, TB3 – Zone Inputs

SeaHawk Leak Detection Sensing Cable (SC) and dry contact wires connect to the LDRA6 through TB2. A leader cable from the leader cable kit, part #LC-KIT is required for leak detection cable connections. Dry contact wires must be user supplied or may be supplied with your dry contact device. Connect cables and wires as follows:

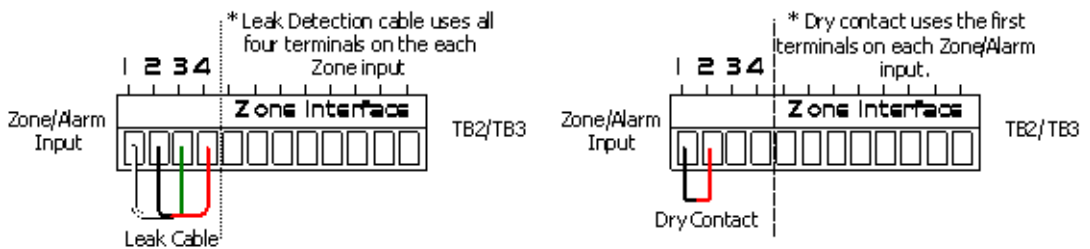
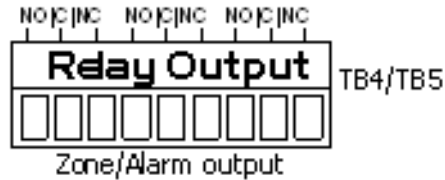

Figure 2.4 TB2, TB3 - Sensing Cable Input Terminal Blocks

Position Leak Detection Cable		Dry Contact Wire
TB3-1	Zone 1 White	Zone 1 Input-1
TB3-2	Zone 1 Black	Zone 1 Input-2
TB3-3	Zone 1 Green	N/A
TB3-4	Zone 1 Red	N/A
TB3-5	Zone 2 White	Zone 2 Input-1
TB3-6	Zone 2 Black	Zone 2 Input-2
TB3-7	Zone 2 Green	N/A
TB3-8	Zone 2 Red	N/A
TB3-9	Zone 3 White	Zone 3 Input-1
TB3-10	Zone 3 Black	Zone 3 Input-2
TB3-11	Zone 3 Green	N/A
TB3-12	Zone 3 Red	N/A
TB2-1	Zone 4 White	Zone 4 Input-1
TB2-2	Zone 4 Black	Zone 4 Input-2
TB2-3	Zone 4 Green	N/A
TB2-4	Zone 4 Red	N/A
TB2-5	Zone 5 White	Zone 5 Input-1
TB2-6	Zone 5 Black	Zone 5 Input-2
TB2-7	Zone 5 Green	N/A
TB2-8	Zone 5 Red	N/A
TB2-9	Zone 6 White	Zone 6 Input-1
TB2-10	Zone 6 Black	Zone 6 Input-2
TB2-11	Zone 6 Green	N/A
TB2-12	Zone 6 Red	N/A

## 2.1.4 TB5, TB4 – Zone Alarm Relays

These are the Zone Alarm Relay output terminal blocks (Form C). A status LED is located above each relay, which will indicate the state of the relay (on/off). These relays can be configured as supervised or unsupervised, latched or unlatched (unsupervised and unlatched by factory default). Connect the Zone Alarm Relay wires to TB3 and TB4 as follows:



**Figure 2.5** TB4, TB5 - Alarm Relay Output Terminal Blocks

TB5-1 Zone 1 alarm relay normally open (NO)  
 TB5-2 Zone 1 alarm relay common (C)  
 TB5-3 Zone 1 alarm relay normally closed (NC)

TB5-4 Zone 2 alarm relay normally open (NO)  
 TB5-5 Zone 2 alarm relay common (C)  
 TB5-6 Zone 2 alarm relay normally closed (NC)

TB5-7 Zone 3 alarm relay normally open (NO)  
 TB5-8 Zone 3 alarm relay common (C)  
 TB5-9 Zone 3 alarm relay normally closed (NC)

TB4-1 Zone 4 alarm relay normally open (NO)  
 TB4-2 Zone 4 alarm relay common (C)  
 TB4-3 Zone 4 alarm relay normally closed (NC)

TB4-4 Zone 5 alarm relay normally open (NO)  
 TB4-5 Zone 5 alarm relay common (C)  
 TB4-6 Zone 5 alarm relay normally closed (NC)

TB4-7 Zone 6 alarm relay normally open (NO)  
 TB4-8 Zone 6 alarm relay common (C)  
 TB4-9 Zone 6 alarm relay normally closed (NC)



## 2.1.5 TB6 – Summary Relay

This is the Summary Relay output terminal block (Form C). A status LED is located to the right of the relay, which will indicate the state of the relay (on/off). This relay can be configured as supervised or unsupervised, latched or unlatched. Connect the Summary Relay wires to TB6 as follows:

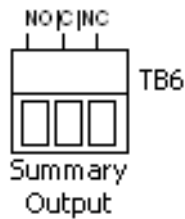
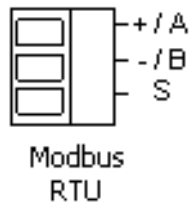

**Figure 2.6** TB6 - Summary Relay Output Terminal Block

- TB6-1 Summary alarm normally open (NO)
- TB6-2 Summary alarm common (C)
- TB6-3 Summary alarm normally closed (NC)

## 2.1.6 TB7 – RS485 Connection

The LDRA6 can communicate with other devices through the RS485 terminal block. Wire as follows:



**Figure 2.7** TB7 - RS485 Terminal Block

- TB7-1 + or A wire
- TB7-2 - or B wire
- TB7-3 Shield or GND wire

## 2.2. SW1– Relay and Alarm Function

### 2.2.1 SW1, Position 1: Summary Relay Supervised/Unsupervised

The SW1, position 1 configures the Summary Alarm relay as supervised or unsupervised. If a relay is supervised, the relay picks until power goes off or until an alarm is detected. The alarm then releases to announce a change in state. An unsupervised relay picks only when an alarm is detected.

- 1 = Supervised
- 0 = Unsupervised (factory default)

### 2.2.2 SW1, Position 2: Relays Latched/Unlatched

The SW1, position 2 configures all relays as latched or unlatched. If a relay is latched, the relay will remain in an alarm condition until the Reset switch is pressed. If a relay is unlatched, the relay will remain in alarm until either the Reset switch is pressed, or the condition that tripped the relay goes away.

- 1 = Latched
- 0 = Unlatched (factory default)

### 2.2.3 SW1, Position 3: Zone Relay Linkage

The SW1, position 3 configures all Zone Alarm Relays to link together and pick simultaneously upon alarm. When this switch is turned on, if a zone goes into alarm, all six zone alarm relays and the summary alarm relay will pick. When this switch is turned off, if a zone goes into alarm, only the zone alarm relay for the zone that is in alarm and the summary alarm relay will pick.

- 1 = Individual Zone Alarm Relays Linked
- 0 = Individual Zone Alarm Relays Not Linked (factory default)

### 2.2.4 SW1, Position 4: Zone Relays Supervised / Unsupervised

The SW1, position 4 configures the individual Zone Alarm Relays as supervised or unsupervised. If a relay is supervised, the relay picks until power goes off or until an alarm is detected. The alarm then releases to announce a change in state. An unsupervised relay picks only when an alarm is detected.

- 1 = Supervised
- 0 = Unsupervised (factory default)

### 2.2.5 SW1, Position 5: Leak Alarm Delay

The SW1, position 5 switch designates the unit's leak delay time. Setting this switch to "off" delays the default leak alarm by 15 seconds. Setting this switch to 'on' designates the leak alarm delay to use the value specified through the unit's craft port.

- 1 = Leak Alarm Delay set through Craft Port
- 0 = Leak Alarm Delay set at 15 seconds (factory default)

### 2.2.6 SW1, Position 6: Ability to Silence Summary Relay

The SW1, position 6 switch gives the Summary Alarm Relay the option of being silenced or not. If the Summary Alarm Relay can be silenced, the relay returns to normal when the Quiet/Test/Reset button is pressed. If the Summary Alarm Relay can not be silenced, the relay stays picked until the alarm condition is cleared.

- 1 = Summary Alarm Relay is able to be silenced
- 0 = Summary Alarm Relay is not able to be silenced (factory default)

### 2.2.7 SW1, Positions 7 and 8: Re-alarm Time

The SW1, position 7 and 8 configures the unit's re-alarm time. Set the switches as below for desired (approximate) re-alarm times:

- 1 1 = 24 hours
- 0 1 = 16 hours
- 1 0 = 8 hours
- 0 0 = Disabled; no re-alarms once silenced (factory default)

## 2.3. SW2 – Modbus Addressing

The SW2, configures the unit's EIA-485 address. The unit's address is set in bits and can range from 00000001 to 11111110 (1-254 in decimal notation).

- 00000000 = No Address (factory default)
- 00000001 = 1
- 00000010 = 2
- 00000011 = 3
- ...
- 11111101 = 253
- 11111110 = 254

## 2.4. SW4 through SW9

SW4 through SW9 configure each zone as a Leak Detection Cable input or a Dry Contact input. If configured as a Leak Detection Cable input, the zone requires a 4-wire leak detection cable (SC) to monitor. If configured as a Dry Contact input, the zone requires a 2-wire dry contact device to monitor. If any zone is not desired to be used, set the zone to Dry Contact and normally open (factory default) to avoid unwanted alarms.

SW4 Up	=	Zone 1 is a Dry Contact input
SW4 Down	=	Zone 1 is a Leak Detection input
SW5 Up	=	Zone 2 is a Dry Contact input
SW5 Down	=	Zone 2 is a Leak Detection input
SW6 Up	=	Zone 3 is a Dry Contact input
SW6 Down	=	Zone 3 is a Leak Detection input
SW7 Up	=	Zone 4 is a Dry Contact input
SW7 Down	=	Zone 4 is a Leak Detection input
SW8 Up	=	Zone 5 is a Dry Contact input
SW8 Down	=	Zone 5 is a Leak Detection input
SW9 Up	=	Zone 6 is a Dry Contact input
SW9 Down	=	Zone 6 is a Leak Detection input

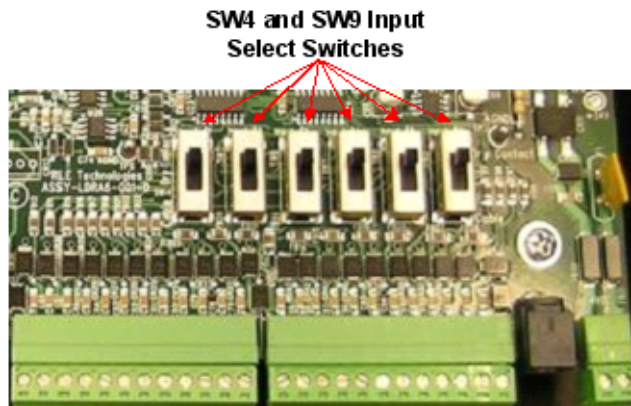
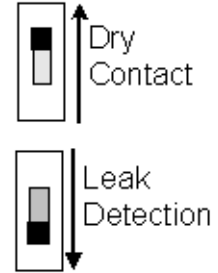
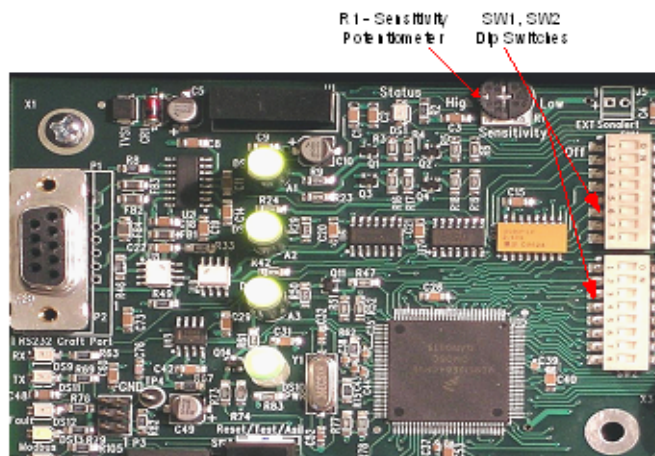

Figure 2.8 SW4 - SW9 Zone Configuration Switches

## 2.5. R1 – Leak Detection Cable Sensitivity Setting

This potentiometer allows users to manually adjust the sensitivity setting for all six zones. Turn the dial clockwise to make the zone less sensitive. This means a leak will be reported in that zone when a large amount of water is present. Turn the dial counterclockwise to make the zone more sensitive. This means a leak will be reported for the zone when a small amount of water is present.

This potentiometer can be overridden through the LDRA6's craft port configuration for individual zones (see 4.3.3, "sens – Leak Zone Sensitivity" on page 29 for details).



**Figure 2.9** R1 - Adjust Leak Detection Cable Sensitivity



## INSTALLATION

### 3.1. Before You Begin

The LDRA6 is a wall mounted device. To secure the device to the wall, first open the door of the enclosure. There are knockouts on the top and bottom of the enclosure. Remove as many as necessary. Use drywall anchors and the holes in the back of the enclosure to secure the unit to the wall.

### 3.2. Connect the Water Leak Detection Cable

A leader cable kit (RLE part LC-KIT) is required per zone to connect the LDRA6 to SeaHawk Leak Detection Cable (SC). A leader cable is included in each LC-KIT; one end of this leader cable connects into the LDRA6. This end of the cable is finished with stripped, bare wires. The other end features a mating connector which connects with the SC. The end of the cable zone requires a removable end terminator (EOL) which is also included in a leader cable kit (LC-KIT).

**NOTE** One Leader Cable Kit (RLE part LC-KIT) is required for each zone of leak detection sensing cable you would like to connect the LDRA6. Each LC-KIT includes a 15 foot (4.57m) leader cable and an EOL terminator. The kits are NOT included with the LDRA6, and can be purchased separately.

To connect the leader cable to the LDRA6, connect the wires (4) to the appropriate zone position of the terminal block connectors (see section 2.1.3, “TB2, TB3 – Zone Inputs” on page 14 for more wiring details). Adjust the appropriate zone configuration for Leak Detection input (see section 2.4., “SW4 through SW9” on page 20 for more details).

Once the leader cable is plugged into the terminal block, it is ready to be connected to the SC. To do this, unscrew the EOL terminator from the end of the leader cable. Attach the first length of SC to the leader cable. Route the SC according to the cable layout diagram, if provided. Lay the cable according to Figure 3.1 and 3.2.1, “Secure the Cable to the Floor” on page 24. Secure the EOL terminator on the unoccupied end of the SC.

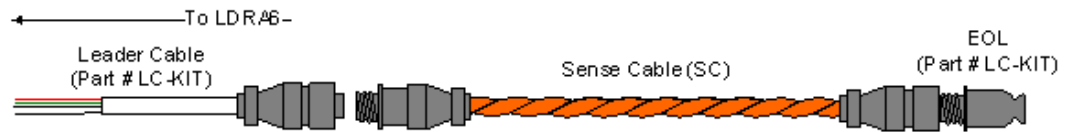

**Figure 3.1** Water Leak Detection Sensing Cable Connection

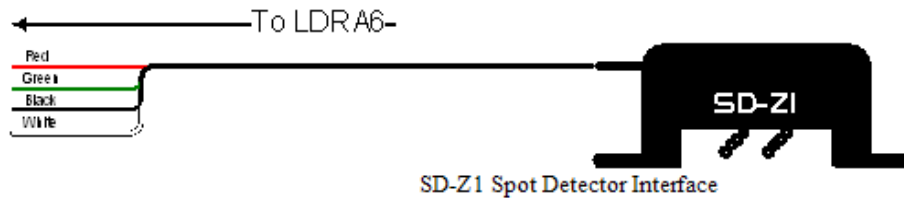

**Figure 3.2** SD-Z1 Spot Detector Connection

The SD-Z1 connects to the LDRA6 in a manner similar to the LC-Kit. One SD-Z1 is designed to connect to each Zone input on the LDRA6. If multiple points are need to be monitored on one zone input, it is recommended to use the SD-Z style spot detector which connects together in series for multiple detection points.

### 3.2.1 Secure the Cable to the Floor

Secure the cable to the floor with either J-clips (part #JC) or one of the other approved methods shown in Figure 3-2. J-clips are the manufacturer's recommended installation method.

§ Place one J-clip every three feet along the length of the SC. Place one J-clip at each turn of the cable.

§ If the cable is installed over an obstruction, clip the cable on both sides, as close to the obstruction as possible.

§ Do not install the cable directly in front of an air conditioner. Allow a minimum of 6 feet (1.83m) between the unit and the cable. If the SC is too close to the air conditioning unit's air stream, the moisture from the humidifier may cause false leak readings. If the cable must be installed in front of an air conditioning unit, place the J-clips 12 to 18 inches (.305m to .457m) apart.

**Note** It is important to finish the end of the SeaHawk Leak Detection Cable (SC) with the end-of-line terminator (EOL). If the EOL terminator is not present, a cable fault will register. Note any variances between the cable layout diagram and the actual cable installation. Wait approximately one minute. No alarm should be present.



### 3.2.2 Recommended Cable Installation

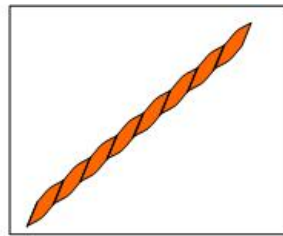

Laid freely on the floor.  
Recommended in Spaces with no access



Secure to floor with Non-Conductive Mastic

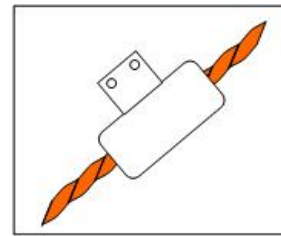

Installed in Protective Covering

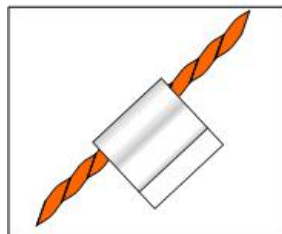

Secure to floor with J-Clip

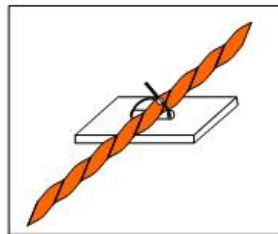

Secure to floor with Zip Tie



Secure to pedestal with tie wrap.  
Do Not Secure as Shown

Figure 3.3 Cable Installation Methods

### 3.3. Apply Power to the Unit

Once cable for all the desired leak detection zones has been connected to the unit, power may be applied. The LDRA6 operates on 24VDC power supplied by a wall adapter or a direct line. A power supply should be run to the location of the unit.

#### 3.3.1 Power via Wall Adapter

The LDRA6 can be powered by a wall adapter. Before connecting the wall adapter to the LDRA6, unplug the adapter from the wall. If the adapter has a connector on the end, feed the cord through one of the knockouts in the enclosure and plug it directly into the 24VDC receptacle located at POW1. Plug the other end of the adapter into the wall. The LDRA6 should power up immediately.

#### 3.3.2 Power via Direct Line

If the adapter does not have a connector on the end, strip the end of the adapter line so the two wires inside are exposed. Strip the end of each of the two wires and feed them into the enclosure. Insert the two wires into the terminal block labeled TB1. The minus, or ground, wire is placed into the right opening in the terminal block. The plus, or live, wire is placed into the left opening in the terminal block.

Once all the wires have been placed inside the terminal block, tighten the three screws across the bottom of the terminal block until the wires are securely held in place. Plug the other end of the wall adapter into the wall. The LDRA6 should power up immediately.

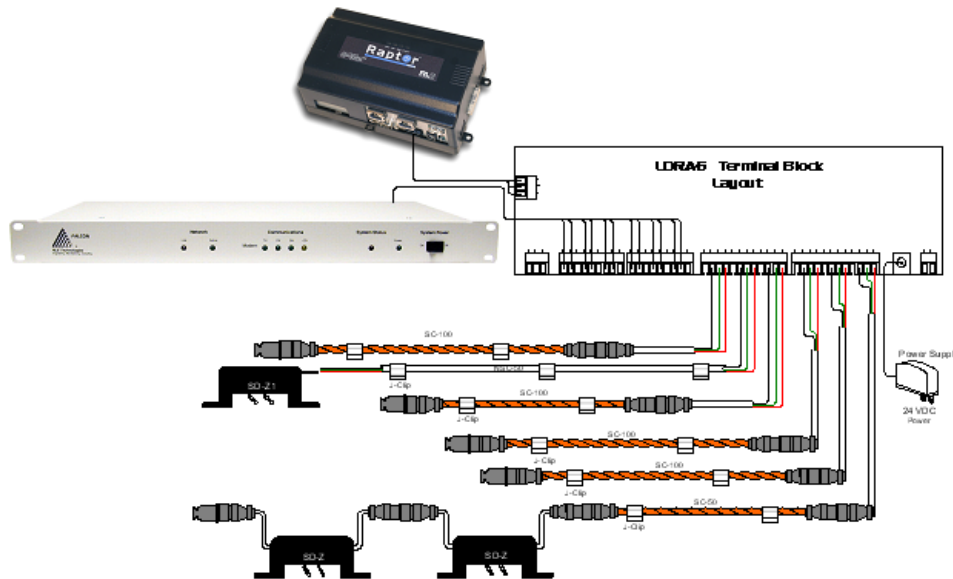

Figure 3.4 Wiring Diagram

## EIA-232 INTERFACE

### 4.1. Boot-Up

Make sure the EIA-232 port is connected to a PC or terminal with a straight through cable. When the LDRA6 is powered up, the boot ROM and flash program code are verified. The Screen displayed below should appear on the terminal or terminal emulation software.

```
LDZ/Rasp6 Bootloader - LDZ6BOOT V2.1
Firmware Prgm Id: LDZ6/RASP6 V2.1
checksum valid

LDZ/Rasp6 bootup
LDZ6/RASP6 V2.1
Reading EEprom.....
..... ok
Modbus Addr:0 9600,8,N,1
```

Figure 4.1 EIA-232 Interface - Bootloader Screen

## 4.2. Help Menu

Once the system reaches this point, type? and press **Enter** to display the Help Menu. The Help Menu lists the function commands for the LDRA6.

```

Help Menu - LDZ6/RASP6 V2.1
c   - view/change CC settings
ld  - view/change leak delay
sens - view/change leak zone sensitivity
e   - view eeprom data
er  - erase eeprom data - restores factory defaults
mbb - change modbus baud rate
mbp - change modbus parity
mr  - reset modbus port/statistics
m   - view modbus port settings/statistics
t   - toggle modbus trace on/off
z   - display leak zone readings
sr  - summary relay mode
zr  - zone relay mode
x   - exit to bootloader

```

Figure 4.2 EIA-232 Interface - Help Menu

## 4.3. Function Commands

### 4.3.1 c – Contact Closure Settings

**c** displays the current contact closure settings for each zone. To adjust a zone's configuration, use the following format: **cX/type/offcolor/oncolor/delay**.

- ◆ **X** is the zone number and can range from 1-6 for each input.
- ◆ **type** is the contact closure setting; use "no" for normally open, "nc" for normally closed, or "st" for a status point.
- ◆ **off-color** is the normal condition (non-alarm) LED color.
- ◆ **on color** is the alarm condition LED color.
- ◆ The colors for LEDs can be green, yellow, red, or none.
- ◆ **delay** is the number of seconds the alarm must be active before annunciated and can range from 0 to 999 seconds.

```

** 1: CC / 2: CC / 3: CC / 4: CC / 5: CC / 6: CC **
cX/type/offcolor/oncolor/delay
c1/no/green/red/0
c2/no/green/red/0
c3/no/green/red/0
c4/no/green/red/0
c5/no/green/red/0
c6/no/green/red/0

```

Figure 4.3 EIA-232 Interface - Contact Closure Settings

### 4.3.2 Id – Leak Delay Setting

**Id** displays the current leak alarm delay in seconds. This is the number of seconds the leak alarm must be detected before annunciated. The leak alarm delay can range from 0 to 999 seconds.

Use the format **Id/x** where x is the number of seconds for the leak alarm delay.

This value applies to all zones configured for Leak Detection. SW1 position 5 determines if this RS232 configured value is used (see section 2.2.5, “SW1, Position 5: Leak Alarm Delay” on page 19).

### 4.3.3 sens – Leak Zone Sensitivity

**sens** displays the current leak detection sensitivity settings for each zone. The first value displayed is the value read from R1, the sensitivity dial on the LDRA6 board. Each zone is displayed in the format **x:yyy/zzz**, where x is the zone, yyy is the value currently being used for sensitivity (*in micro amps read by the sensing cable, yyy can range from 25 to 300*), and zzz is the manually entered value through the craft port (*factory default is 0*). Values shown below uses sensitivity set to High (*fully counterclockwise*).

```
Pot: 25 1:25/0 2:25/0 3:25/0 4:25/0 5:25/0 6:25/0
```

Figure 4.4 EIA-232 Interface - Display Current Leak Zone Settings

To override the manual sensitivity dial setting, enter a new value for each desired zone. Using a value of 0 will enable desired zone to use manual sensitivity dial setting. Use the format **sensX/yyy** to override a zone's setting. Example: **sens1:300** sets Zone 1 to a sensitivity of 300 micro amps. Type **sens** and press Enter again to viewing the Leak Zone Sensitivity settings after entering new value displays the following:

```
Pot:25 1:300/300 2:25/0 3:25/0 4:25/0 5:25/0 6:25/0
```

Figure 4.5 EIA-232 Interface - Override Manual Leak Sensitivity Settings

### 4.3.4 e – View Eeprom Data

This function is a reserved command used for advanced diagnostic purposes only.

### 4.3.5 er – Erase Eeprom Data – Restores Factory Defaults

er will erase all RS232 configured settings and restore them all to factory default values.

### 4.3.6 mbb – View / Change Modbus Baud Rate

mbb will display modbus address, baud rate, data bits, parity, and stop bits. Default values are displayed below.

```
Modbus Addr:0 9600,8,N,1
```

Figure 4.6 EIA-232 Interface - Help Menu

To change modbus baud rate, use the format **mbb/xxxx** where xxxx is the baud rate. Valid selections for baud rate are 1200, 2400, 9600 and 19200.

### 4.3.7 mbp – View / Change Modbus Parity

mbp will display modbus address, baud rate, data bits, parity, and stop bits. Default values are displayed below.

```
Modbus Addr:0 9600,8,N,1
```

Figure 4.7 EIA-232 Interface - Modbus Parity

To change modbus parity rate, use the format **mbp/x** where x is the parity. Valid selections for parity are:

- ◆ e – even
- ◆ o – odd
- ◆ n – none

### 4.3.8 mr – Reset Modbus Port and Statistics

mr will reset all RS485 Modbus counters.

### 4.3.9 m – View Modbus Port Settings and Statistics

**m** will display the current EIA-485 Modbus port settings and logged statistics. Initial values appear as:

```
Modbus Addr:0 9600,8,N,1
overruns:      0
parity_errors: 0
noise_errors:  0
framing_errors: 0
inpackets:     0
crc_errors:    0
for me:        0
not for me:    0
```

Figure 4.8 EIA-232 Interface - Modbus Port Setting and Statistics

### 4.3.10 t – Toggle Modbus Trace On/Off

**t** will toggle Modbus tracing with packet viewing from the EIA-485 port over the EIA-232 port. This is a command for advanced diagnostic purposes only.

### 4.3.11 z – Display Leak Zone Readings

**z** will display the present Leak Detection Cable readings. The Leak Zone table will display the reading for each leg of cable and the present leakage current reading for each zone.

```
Z1: Leg1: 0    Leg2: 0    Leakage: 0
Z2: Leg1: 0    Leg2: 0    Leakage: 0
Z3: Leg1: 0    Leg2: 0    Leakage: 0
Z4: Leg1: 0    Leg2: 0    Leakage: 0
Z5: Leg1: 0    Leg2: 0    Leakage: 0
Z6: Leg1: 0    Leg2: 0    Leakage: 0
```

Figure 4.9 EIA-232 Interface - Current Leak Zone Readings

### 4.3.12 sr – Summary Relay Mode

**sr** will display the current configuration of the summary relay. You can select the summary relay to either change state on leak/fault or just a fault condition. Enter, sr <space> summary for notification on a leak/fault condition. Enter, sr <space> fault for notification on a fault condition.

```
sr
sr/summary (summary/fault)
sr fault
sr/fault (summary/fault)
```

Figure 4.10 EIA-232 Interface - Summary Relay Configuration

### 4.3.13 zr – zone relay mode

**zr** will display the current configuration of the zone relays. You can select the zone relays to either change state on leak/fault (summary) or just a leak condition. Enter, **zr <space> summary** for notification on a leak/fault condition. Enter, **zr <space> leak** for notification on a leak condition.

```
zr
zr/summary (summary/leak)
zr leak
zr/leak (summary/leak)
```

Figure 4.11 EIA-232 Interface - Zone Relay Configuration

### 4.3.14 x – Exit to Bootloader

**x** will exit the application code and only the bootloader will be running.





# MODBUS COMMUNICATIONS

This document describes the Modbus communications protocol as supported by the LDRA6. It includes details and information on how to configure the LDRA6 for communications via Modbus network.

## A.1. Modbus Implementation of the LDRA6

The LDRA6 is capable of communicating via the half-duplex EIA-485 serial communication standard. The LDRA6 is configured to act as a slave device on a common network. The EIA-485 medium allows for multiple devices on a multi-drop network. The LDRA6 is a slave only device and will never initiate a communications sequence.

### A.1.1 Modes of Transmission

The Modbus protocol uses ASCII and RTU modes of transmission. The LDRA6 supports only the RTU mode of transmission, with 8 data bits, even, odd or no parity and one stop bit.

Every Modbus packet consists of four fields:

- ◆ Slave Address Field
- ◆ Function Field
- ◆ Data Field
- ◆ Error Check Field (Checksum)

#### A.1.1.1 Slave Address Field

The slave address field is one byte in length and identifies the slave device involved in the transaction. Valid address range is between 1 and 254. SW2 on the LDRA6 board sets the address. The firmware program constantly reads dip SW2. Any changes are updated on the fly. Close the SW2 positions that correspond to the binary number of the address.

### A.1.1.2 Function Field

The function field tells the LDRA6 which function to perform. Function codes are designed to invoke a specific action by the LDRA6.

### A.1.1.3 Data Field

The data field varies in length depending on whether the message is a request or a response to a packet. This field typically contains information required by the LDRA6 to perform the command specified or to pass back data to the master device.

### A.1.1.4 Error Check Field

The error check field consists of a 16-bit (2 byte) Cyclical Redundancy Check (CRC16). It allows the LDRA6 to detect a packet that has been corrupted with transmission errors.

## A.2. Packet Communications for the LDRA6

### A.2.1 Read Output Registers

To read the LDRA6 parameter values, the master must send a Read Output Registers request packet. The Read Output Registers request packet specifies a start register and the number of registers to read. The start register is numbered from zero (40001 = zero, 40002 = one, etc.).

Read Registers Request Packet	Read Registers Response Packet
Slave Address (1 byte)	Slave Address (1 byte)
03 (Function code) (1 byte)	03 (function code) (1 byte)
Start Register (2 bytes)	Byte count (1 byte)
# of registers to read (2 bytes)	First register (2 bytes)
Crc Checksum (2 bytes)	Second register (2 bytes)
	...
	Crc Checksum (2 bytes)

**Table A.1** Read Output Registers Packet Structure

Register	Name	Description	Units	Range
40001	Leak Threshold Zone 1	Trip current for leak alarm	μAmps	0-65535
40002	Leak Threshold Zone 2	Trip current for leak alarm	μAmps	0-65535
40003	Leak Threshold Zone 3	Trip current for leak alarm	μAmps	0-65535
40004	Leak Threshold Zone 4	Trip current for leak alarm	μAmps	0-65535

**Table A.2** Output Registers

Register	Name	Description	Units	Range
40005	Leak Threshold Zone 5	Trip current for leak alarm	μAmps	0-65535
40006	Leak Threshold Zone 6	Trip current for leak alarm	μAmps	0-65535
40007	Reserved			
40008	Reserved			
40009	Reserved			
40010	Silence Alarm	Set to 1 to silence audible alarm	1 = Silence	0-65535
40011	Reset Alarm	Set to 1 to reset alarms	1 = Reset Alarm	0-65535
40012	Reserved			
40013	Reserved			
40014	Reserved			
40015	Reserved			
40016	Reserved			
40017	Reserved			

**Table A.2** [Output Registers \(continued\)](#)

## A.2.2 Read Input Registers

To read the LDRA6 input values, the master must send a Read Input Registers request packet. The Read Input Registers request packet specifies a start register and the number of registers to read. The start register is numbered from zero (30001 = zero, 30002 = one, etc.).

Read Registers Request Packet	Read Registers Response Packet
Slave Address (1 byte)	Slave Address (1 byte)
04 (Function code) (1Byte)	04 (Function code) (1 byte)
Start Register *2 bytes)	Byte count (1 byte)
# of register to read (2 bytes)	First register (2 bytes)
Crc Checksum (2 bytes)	Second register (2 bytes)
	...
	Crc Checksum (2 bytes)

**Table A.3** [Read Input Registers Packet Structure](#)

Register	Name	Description	Units	Range
30001	Status	Bit Level Status (see Table 5)	None	0-65535
30002	Leak Current Zone 1	Leakage current on cable	μAmps	0-65535
30003	Leak Current Zone 2	Leakage current on cable	μAmps	0-65535
30004	Leak Current Zone 3	Leakage current on cable	μAmps	0-65535
30005	Leak Current Zone 4	Leakage current on cable	μAmps	0-65535
30006	Leak Current Zone 5	Leakage current on cable	μAmps	0-65535
30007	Leak Current Zone 6	Leakage current on cable	μAmps	0-65535
30008	Input Selection	Bit Level Status (see Table 6)	None	0-65535
30009	Reserved			
30010	Version	Firmware version	xx.xx X 100	0-65535

**Table A.4** Input Registers

Bit	Read Registers Response Packet
00	1 = Zone 1: Leak is Detected / Contact Closure Alarm
01	1 = Zone 2: Leak is Detected / Contact Closure Alarm
02	1 = Zone 3: Leak is Detected / Contact Closure Alarm
03	1 = Zone 4: Leak is Detected / Contact Closure Alarm
04	1 = Zone 5: Leak is Detected / Contact Closure Alarm
05	1 = Zone 6: Leak is Detected / Contact Closure Alarm
06	0
07	0
08	1 = Zone 1 Cable Break Alarm
09	1 = Zone 2 Cable Break Alarm
10	1 = Zone 3 Cable Break Alarm
11	1 = Zone 4 Cable Break Alarm
12	1 = Zone 5 Cable Break Alarm
13	1 = Zone 6 Cable Break Alarm

**Table A.5** Status Flags (Register 30001)

Bit	Read Registers Response Packet
14	0
15	0

**Table A.5** Status Flags (Register 30001) (continued)

Bit	Read Registers Response Packet
00	0 = Zone 1 Configured for Leak Detection / 1 = Zone 1 Configured for Dry Contact
01	0 = Zone 2 Configured for Leak Detection / 1 = Zone 2 Configured for Dry Contact
02	0 = Zone 3 Configured for Leak Detection / 1 = Zone 3 Configured for Dry Contact
03	0 = Zone 4 Configured for Leak Detection / 1 = Zone 4 Configured for Dry Contact
04	0 = Zone 5 Configured for Leak Detection / 1 = Zone 5 Configured for Dry Contact
05	0 = Zone 6 Configured for Leak Detection / 1 = Zone 6 Configured for Dry Contact
06-15	0

**Table A.6** Status Flags (Register 30008)

### A.2.3 Present Single Register

To set a LDRA6 parameter value, the master must send a Preset Single Register request packet. The Preset Single Register request packet specifies a register and the data to write to that register. The register is numbered from zero (40001 = zero, 40002 = one, etc.).

Preset Registers Request Packet	Preset Registers Response Packet
Slave Address (1 byte)	Slave Address (1 byte)
06 (*Function code) (1 byte)	06 (Function code) (1 byte)
Register (2 bytes)	Register (2 bytes)
Data (2 bytes)	Data (2 bytes)
Crc Checksum (2 bytes)	Crc Checksum (2 bytes)

**Table A.7** Preset Single Register Packet Structure

## A.2.4 Present Multiple Registers

To set multiple LDRA6 parameter values, the master must send a Preset Multiple Registers request packet. The Preset Multiple Register request packet specifies a starting register, the number of registers, a byte count and the data to write to the registers. The register is numbered from zero (40001 = zero, 40002 = one, etc.).

Preset Registers Request Packet	Preset Registers Response Packet
Slave Address (1 byte)	Slave Address (1 byte)
16 (Function code) (1 byte)	16 (Function code) (1 byte)
Start Register (2 bytes)	Start Register (2 bytes)
# of registers to write (2 bytes)	# of registers (2 bytes)
Byte Count (1 byte)	Crc Checksum (2 bytes)
Data (2 bytes)	
...	
...	
Crc Checksum (2 bytes)	

**Table A.8** Present Multiple Registers Packet Structure

Address SW2 (1..8)		Address SW2 (1..8)		Address SW2 (1..8)		Address SW2 (1..8)	
0	00000000	16	00010000	32	00100000	48	00110000
1	00000001	17	00010001	33	00100001	49	00110001
2	00000010	18	00010010	34	00100010	50	00110010
3	00000011	19	00010011	35	00100011	51	00110011
4	00000100	20	00010100	36	00100100	52	00110100
5	00000101	21	00010101	37	00100101	53	00110101
6	00000110	22	00010110	38	00100110	54	00110110
7	00000111	23	00010111	39	00100111	55	00110111
8	00001000	24	00011000	40	00101000	56	00111000
9	00001001	25	00011001	41	00101001	57	00111001
10	00001010	26	00011010	42	00101010	58	00111010
11	00001011	27	00011011	43	00101011	59	00111011
12	00001100	28	00011100	44	00101100	60	00111100
13	00001101	29	00011101	45	00101101	61	00111101
14	00001110	30	00011110	46	00101110	62	00111110
15	00001111	31	00011111	47	00101111	63	00111111

**Table A.9** Modbus Slave Address

- ◆ For address's 64-127, set SW1-7 to on, then subtract 64 from the address and use the table.

- ◆ For address's 128-191, set SW1-7 to off, #8 to on, then subtract 128 from the address and use the table.
- ◆ For address's 192-254, set SW1-7 & 8 to on, then subtract 192 from the address and use the table.

### A.3. RTU Framing

The example below shows a typical Query/Response from a LDRA6 module.

Slave Address	Functions Code	Starting Register "Msb"	Starting Register "Lsb"	Number of Registers "Msb"	Number of Registers "Lsb"	CRC 16 "Lsb"	CRC 16 "Msb"
02	03	00	32	00	03	E5	FA

Table A.10 Query Sample

Slave Address	Function Code	Count Bytes of Data	Register Data Msb Lsb	Register Data Msb Lsb	Register Data Msb Lsb	CRC 16 "Lsb"	CRC 16 "Msb"
02	03	06	01 58	00 FA	00 54	1B	0D

Table A.11 Response Sample

- ◆ Slave address 2 responds to Function Code 3 with 6 bytes of hexadecimal data and ends with CRC16 checksum.

**Register Values:**

40051 =	0158	(hex)	=	344	(decimal)
40052 =	00FA	(hex)	=	250	(decimal)
40053 =	0054	(hex)	=	84	(decimal)

## A.4. Modbus Mirroring

To use the EIA-485 Modbus mirroring feature set the address on the master LDRA6 to address 255 and then set the address on the slave LDRA6 to 1. The Master unit will then repeat (mirror) any zone alarms that come into the Slave Unit. When using this feature none of the local Alarm/Zone inputs will work on the Master unit, The Master unit is only a repeater for the single slave unit being used.

## A.5. Modbus 485 Termination

The LDRA6 has Modbus EIA-485 termination disabled by default because termination may interfere with some Modbus polling devices. However, if needed, there is an option to enable 100-ohm termination resistors across the EIA-485 A & B lines. Connect the jumper across P4 to enable the termination resistances.



Image: Termination Resistance Jumper – Termination Disabled (Default)



# B

## TROUBLESHOOTING

Problem	Action
No Power <i>Power On LED is Not On</i>	<p><b>Check Power Supply</b>            Check for supply power at TB1 pins 1 and 2 on the bottom right hand corner of PCB.</p> <ol style="list-style-type: none"> <li><b>1</b> If power is not present at TB1 pins 1 and 2, check DC input voltage to wall adapter, if used.</li> <li><b>2</b> If power is not present at TB1 pins 1 and 2, check DC voltage at DC supply source distribution panel.</li> <li><b>3</b> If voltage (power) is present at TB1, please contact RLE Technologies.</li> </ol>

**Table B.1** Troubleshooting Problems with the LDRA6

Problem	Action
Cable Fault on Zone(s)	<p><b>Check for Proper Wiring to Zone Terminal Block</b> Wiring order should be as follows from left to right for each leak detection zone: <i>White, Black, Green</i> and <i>Red</i>.</p> <ol style="list-style-type: none"> <li><b>1</b> If wiring order is correct, disconnect the End-of-Line terminator (EOL) from the end of the orange SC. Then connect the EOL terminator to the end of the leader cable (non-sensing). Hold down Quiet/Test/Reset for two seconds to reset control head.</li> <li><b>2</b> If the cable fault condition goes away, there is a faulty or damaged section of orange SC.</li> <li><b>3</b> If the fault condition does not clear, remove the respective zone terminal block and remove the input wires from the leader cable. Install a jumper wire between pins 1 and 2, and another jumper wire between pins 3 and 4.</li> <li><b>4</b> If condition still exists, please contact RLE Technologies for extra support. If the condition clears, the leader cable or EOL terminator is faulty (open wire(s)).</li> </ol>
Leak Detected on Zone(s)	<p><b>Be sure there is No Water Present on or around the Zone in Alarm</b></p> <ol style="list-style-type: none"> <li><b>1</b> If water is present, dry affected area and reset the controller. If the condition does not clear follow the step below.</li> <li><b>2</b> Remove the End-of-Line terminator (EOL) from the end of the orange SC and install it onto the end of the leader cable. If the condition clears, there is a water leak or damage to the sense cable. Start moving the EOL terminator to the end of each cable section until the water-detected fault reoccurs. If the condition is still present once the EOL terminator has been placed on the end of the leader cable, follow the step below.</li> <li><b>3</b> Disconnect the proper terminal block from the zone in alarm. Place a jumper wire between pins 1 and 2, and place a jumper wire between pins 3 and 4. Plug the terminal block back into the proper socket and push reset on the control head. If the condition is corrected, there is a problem with the leader cable. If the water leak condition is still present, contact RLE Technologies for support.</li> </ol>

**Table B.1** Troubleshooting Problems with the LDRA6 (continued)

**Note** Contamination and/or physical damage to the cable is not covered under warranty. For all other troubleshooting concerns and questions regarding this product, contact RLE Technologies at 970-484-6510 or go to our website at [www.rletech.com](http://www.rletech.com).



## TECHNICAL SPECIFICATIONS

<b>Power</b>		<i>Requires an isolated power supply.</i> 24VDC Isolated @ 600mA max.; requires RLE power supply PSWA-DC-24 (not included)
<b>Inputs</b>		
	<b>Leak Detection Cable</b>	Compatible with SeaHawk sensing cable (not included) or SeaHawk spot detectors (SD-Z and SD-Z1 only; not included)
	<b>Cable Input</b>	Each input requires SeaHawk LC-KIT: 15ft (4.57m) leader cable and EOL (LC-KIT not included)
	<b>Maximum Length</b>	1,000ft (305m) per zone
	<b>Detection Response Time</b>	20-3,600sec, software adjustable in 10sec increments; ±2sec
<b>Outputs</b>		
	Relays	1 Form C Summary Alarm Relay, 1 Form C Alarm 1 Relay, 1 Form C Alarm 2 Relay, 1 Form C Alarm 3 Relay, 1 Form C Alarm 4 Relay, 1 Form C Alarm 5 Relay, 1 Form C Alarm 6 Relay;  1A @ 24VDC, 0.5A resistive @ 120VAC; configurable for supervised or non-supervised, latched or non-latched
<b>Communications Ports</b>		
	<b>EIA-232</b>	9600 baud; Parity none; 8 data bits, 1 stop bit
	<b>EIA-485</b>	1200, 2400, 9600 or 19,200 baud; Parity none, odd, even (programmable); 8 data bits, 1 stop bit

**Table C.1** [Technical Specifications](#)

<b>Protocols</b>	
<b>Terminal Emulation</b> (EIA-232)	VT100 compatible
<b>Modbus</b> (EIA-485)	Slave; RTU Mode; Supports function codes 03, 04, 06 and 16
<b>Alarm Notification</b>	
<b>Audible Alarm</b>	85dBA @ 2ft (0.6m); re-sound (disabled, 8, 16, or 24 hours)
<b>Front Panel Interface</b>	
<b>LED Indicators</b>	Power: 1 green (on/off); Status (1 per zone): 6 tri-color (Power On: green; Alarm: red; Cable Fault: yellow)
Push Buttons	Quiet/Test/Reset: 1
<b>Operating Environment</b>	
<b>Temperature</b>	32° to 122°F (0° to 50°C)
<b>Humidity</b>	5% to 95% RH, non-condensing
<b>Altitude</b>	15,000ft (4,572m) max.
<b>Storage Environment</b>	-4° to 158°F (-20° to 70°C)
<b>Dimensions</b>	10.5"W x 8.0"H x 2.0"D (267mmW x 203mmH x 51mmD)
<b>Weight</b>	6 lbs. (2.72kg)
<b>Mounting</b>	Vertical wall mount
<b>Certifications</b>	CE; ETL listed: conforms to UL STD 61010-1, EN STD 61010-1; certified to CSA C22.2 STD NO. 61010-1; RoHS compliant

**Table C.1** [Technical Specifications \(continued\)](#)